

Twin[®] Sight

Window

Balco's unique Twin window provides two systems in one. The elegantly designed window can slide open or can be folded open. When the windows are slid and folded the effect is that of an open balcony, just fold and slide the windows back again to protect against the elements. The Twin window is simple, easy to operate and is locked/unlocked using an innovative magnetic key. Very little effort is required to open the windows, just a light grip on the frame is needed to push them to one side as the sealed stainless steel ball bearings make each window glide smoothly on the rail. The outside of the Twin window can be cleaned easily from the inside of the balcony thanks to its folding action.

Front

The front of the glazing is often divided into two parts, upper and lower. A clear glazing is usually used within the upper section to provide a clear view from within the balcony. The lower section is often filled with an opaque or solid colour glass to provide privacy to the balcony or act as a decorative feature. The lower frame can consist of different materials, including cladding panels or coloured glass to alter the aesthetics and functionality of the unit. Should it become necessary, these can be replaced safely from inside the balcony by a qualified technician. The handrail is available in a range of designs to provide an attractive finish to the glazing. Aluminium profiles are available in any RAL colour.

Unique features

VentTec is a patented self-ventilating system that is designed to keep the glazing free from condensation and ensure fresh air can enter the balcony, even when the windows are closed. Balco's glazing can be fitted with our patented CleanLine drainage system which will take water away from the glazing facade and redirect it internally through the glazing frame to the ground. Not only does this help with the water management of the building, but it also reduces smears and discolouration caused by running water on the glazing facade.

Accessories

Balco provide a number of optional extras such as flowerpots, floor coverings, blinds, awnings, and LED lighting which can be used to enhance the new glazed balcony.



Maximum width per unit	6.5 m* / unit
Max height	2.8 m*
Noise reduction	~21 dB
Energy savings	~20 %**
Window	Float glass, tempered glass 4-5 mm
Parapet	Laminated glass or other composite material

*The size is influenced by prevalent wind loads and national building regulations.

**Energy savings will vary and are influenced by the surroundings in which the balcony is placed.



Magnetic key



Twin Handle

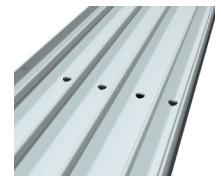

CleanLine - Draining in rail profile.

Lock / Unlock with the magnetic key

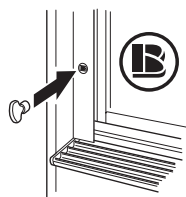

1. Place the magnetic key in the area marked with "B".

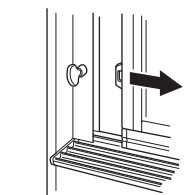

2. The window locks automatically when the magnetic key attaches to the selected area.

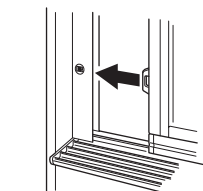

3. To unlock the window, return it to its original position. **NOTE!** The window will not lock until you remove the magnetic key.

This is how you open a window

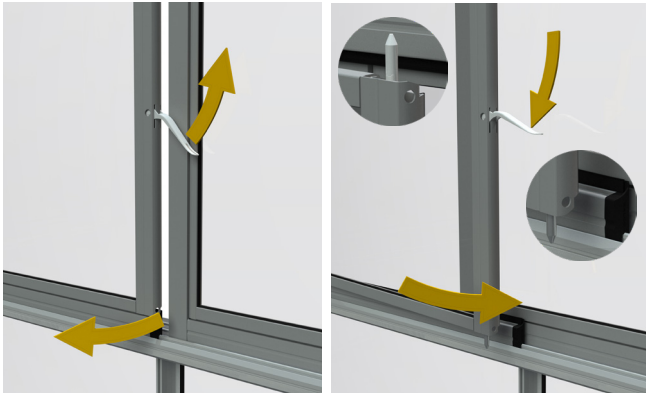

1. Fully raise the window handle and then pull the window toward you.
2. To close the window, simply slide it back into its original position on the rails. Ensure the upper and lower pins from the window are in line with the respective holes in the window frame, then simply lower the handle back into position.

For maximum opening

The description applies to opening from the right side of the window. The illustrations show the opening function from above. If the handle is located on the left side of the window, push the furthest window to the right and the remainder of the windows to the left. Then follow the process for maximum opening below.

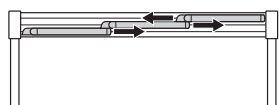

1. Slide the window on the outer rail to the left, and the remaining windows to the right.

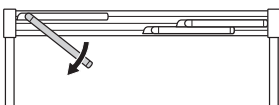

2. Raise the handle and open the window towards you.

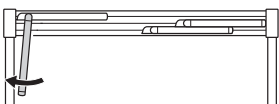

3. Completely open the window.

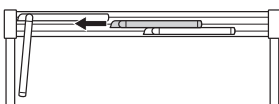

4. Then slide the next window from right to left.

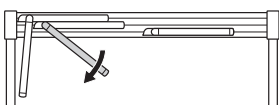

5. Open the next window.

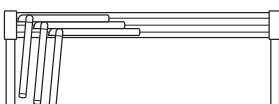

6. Repeat until all the windows have been opened.

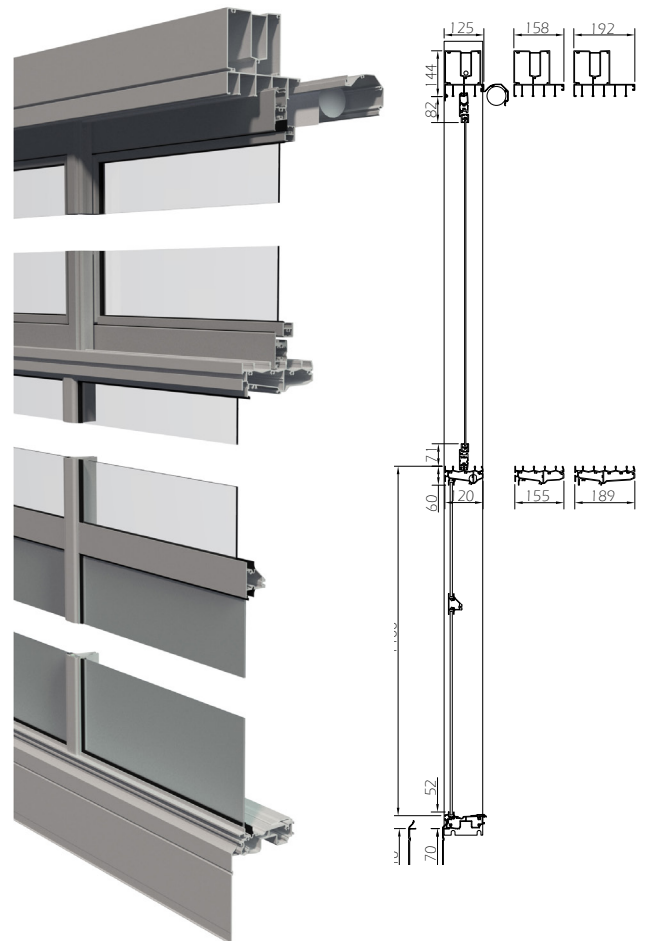

Twin Sight. Cross section and drawing from the side.



Twin Sight. Cross-section of corner post.